

Personnalisez votre kit profils en fonction de vos besoins !

- 1) Sélectionnez les profils qui composeront votre kit de démonstration (échantillons de 20cm) en cochant de manière informatique les cases relatives aux profils souhaités.
- 2) Remplissez vos coordonnées en page 8 et renvoyez-nous ce formulaire par e-mail à info@led-solaire.ch. Nous prendrons contact avec vous.

Remarque : ce matériel vous est mis à disposition gratuitement.

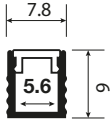

AC1100S (B101)

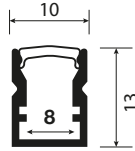

AC5500S (B102)

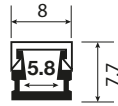

AC1200S (B104)
NEW

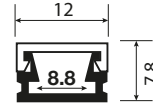

AC1300S (B105)
NEW

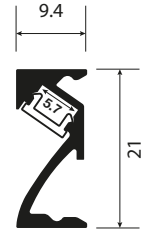

AC2500S (B103)

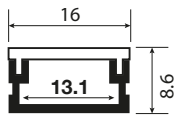

AC1400 (B201)
NEW

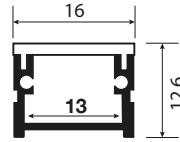

AC1500 (B202)
NEW

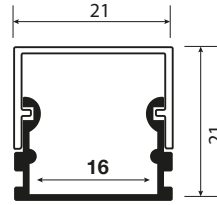

AC1600 (B203)
NEW

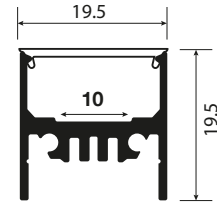
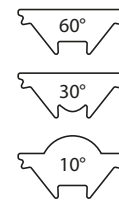

AC1700 (B204)
NEW

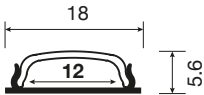

AC2400 (B205)

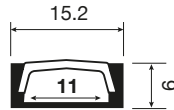

AC5400 (B206)
AC5400B (B207)
AC5400N (B208)
AC5400NN (B208)

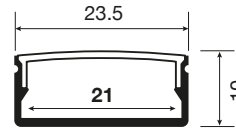

AC5300 (B209)

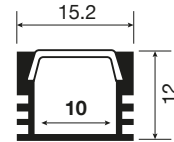

AC5500 (B210)

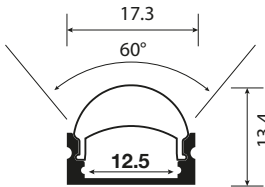

AC5200 (B607)
NEW

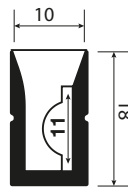

SI1900 (B904)
NEW

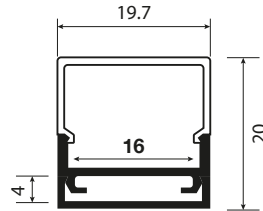

AC6600 (B218)

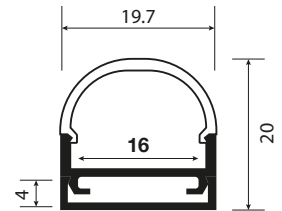

AC6700 (B219)

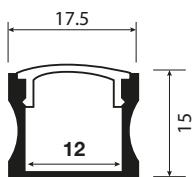

AC5900 (B211)
AC5900NN (B212)
NEW

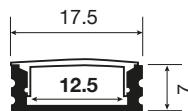

AC5600 (B213)

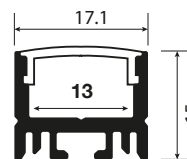

AC3300 (B214)
NEW

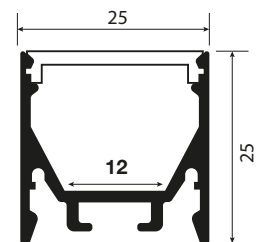

AC6100P (B215)
NEW



ÉCHELLE 1:1

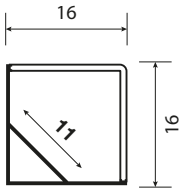

AC6900 (B403)

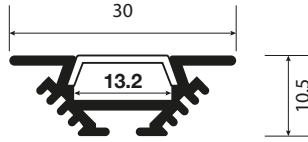

AC6500 (B406)

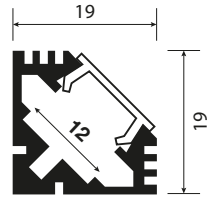

AC5700 (B405)

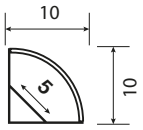

AC6800S (B401)
NEW

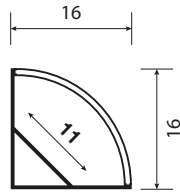

AC6800 (B402)

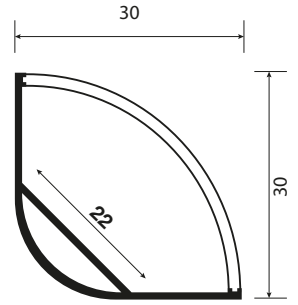

AC6800L (B404)

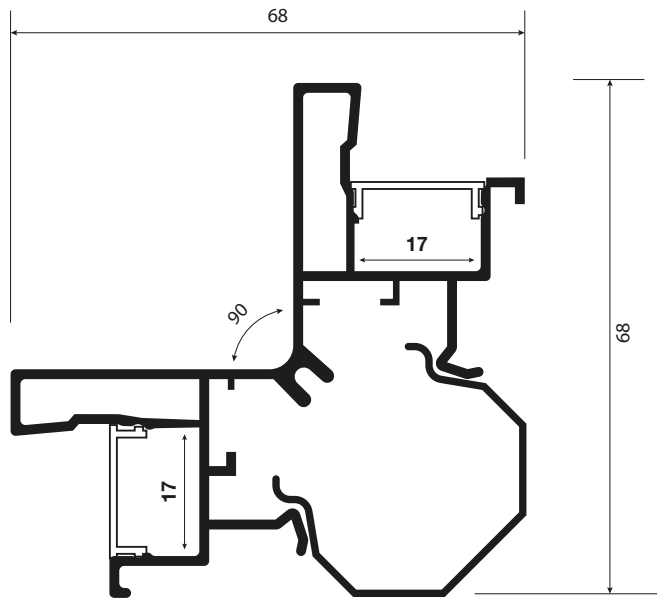

AC4000 (B903)
NEW

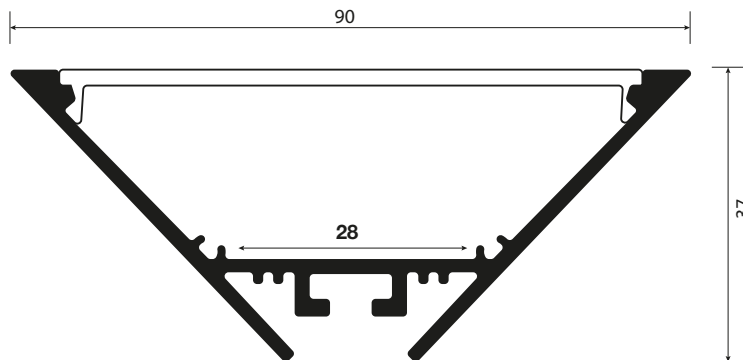

AC7000 (B407)
NEW

ÉCHELLE 1:1

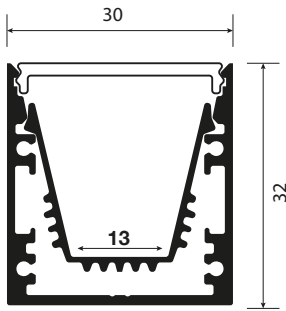

AC6100AP (B217)
NEW

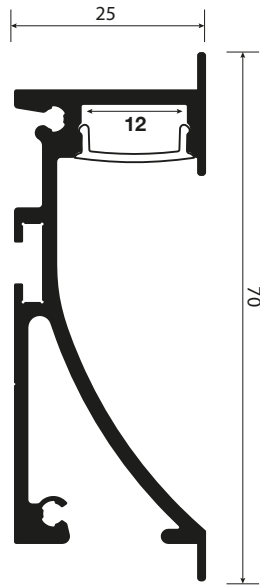

AC2300 (B802)
NEW

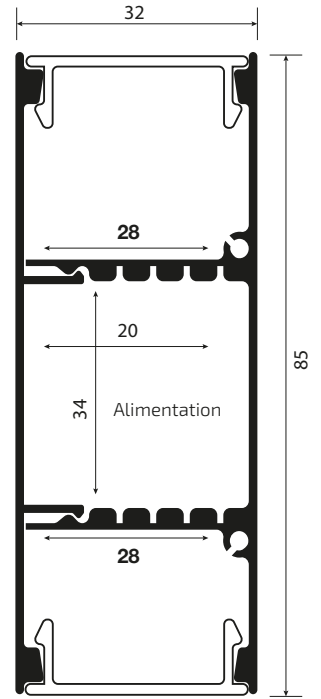

AC6000 (B304)
NEW

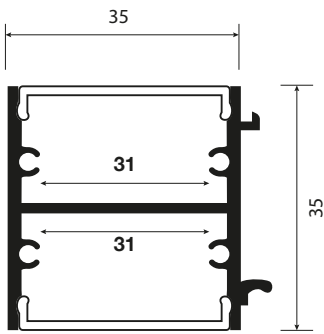

AC2800 (B303)

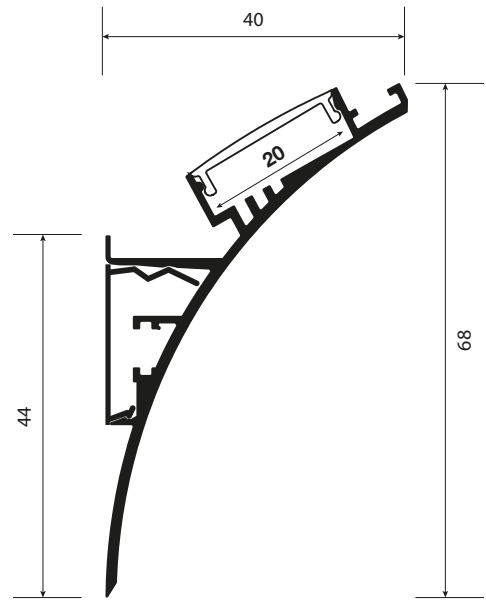
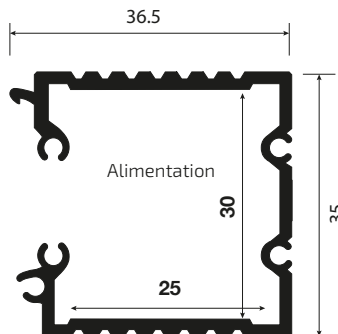

AC4700 (B902)
NEW

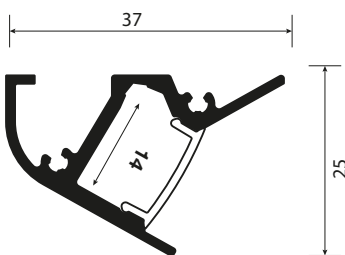

AC7100 (B305)
NEW

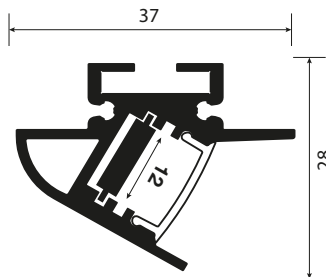

AC7200 (B306)
NEW

ÉCHELLE 1:1

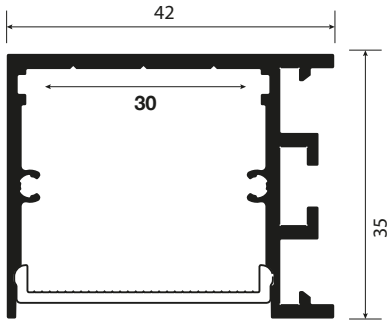

AC6200 (B220)
NEW

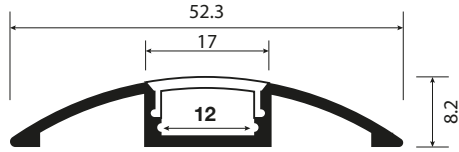

AC2200 (B801)

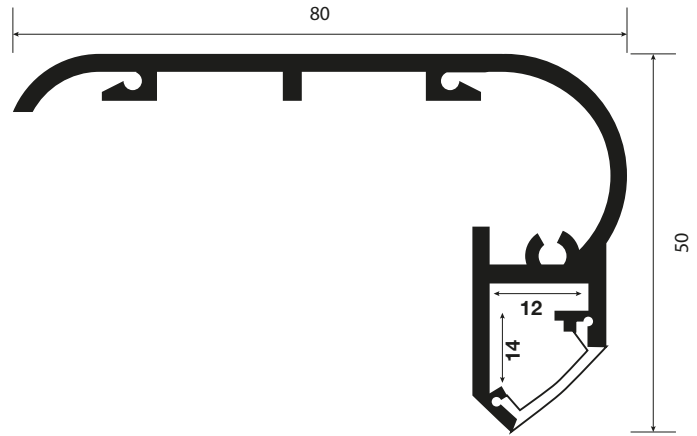

AC2100 (B803)

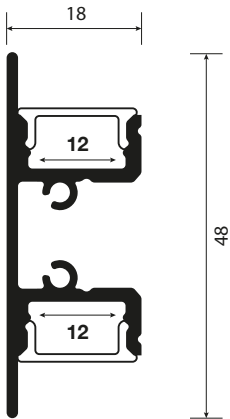

AC2600 (B301)
NEW

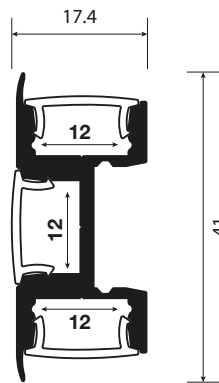

AC2900 (B302)

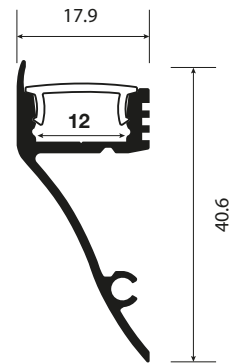

AC2700 (B901)

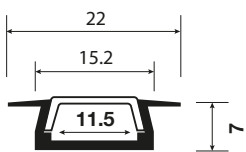

AC8000 (B601)

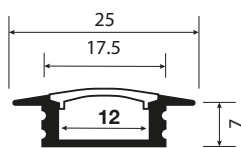

AC8200 (B603)
AC8200N (B604)

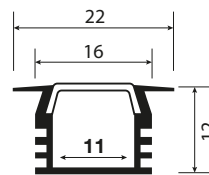

AC8100 (B605)

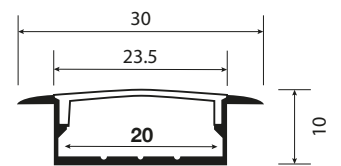

AC8700 (B602)

ÉCHELLE 1:1

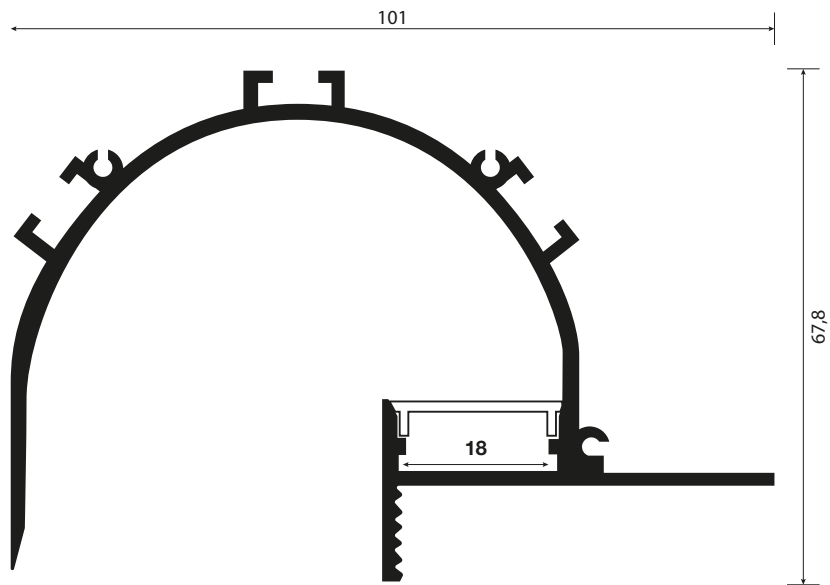

AC9700 (B615)
NEW

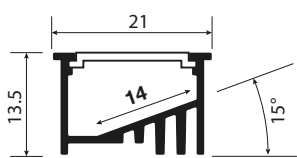

AC8800 (B606)

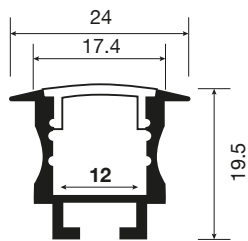

AC8400 (B608)

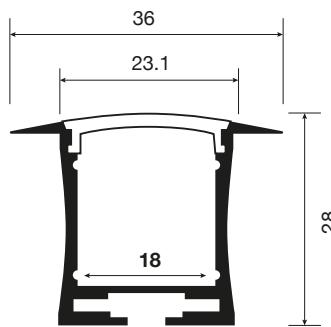

AC8500 (B609)

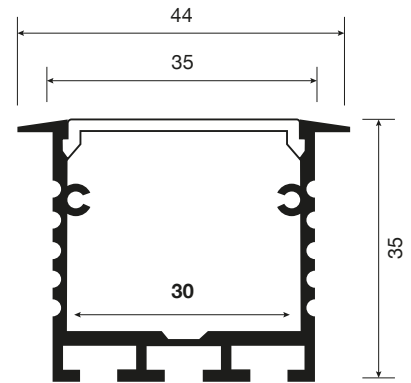

AC8900 (B610)

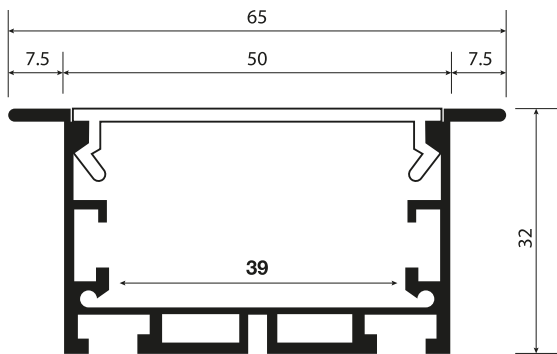

AC8300 (B611)

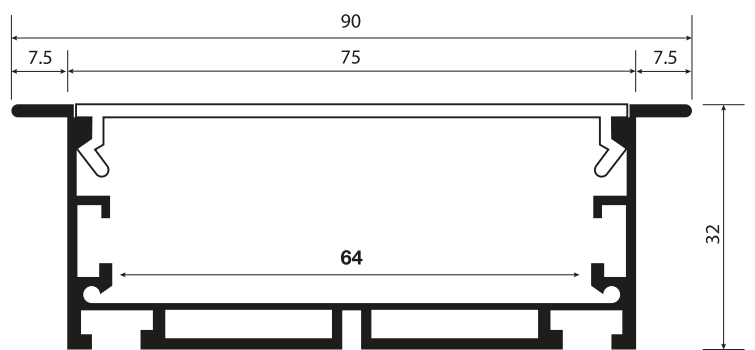

AC8600 (B612)

ÉCHELLE 1:1

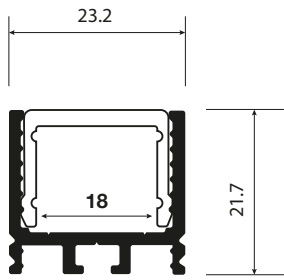

AC9000 (B616)

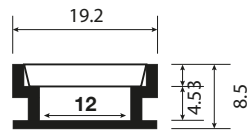

AC5800 (B701)

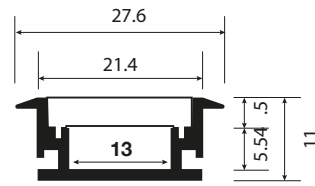

AC5100 (B702)

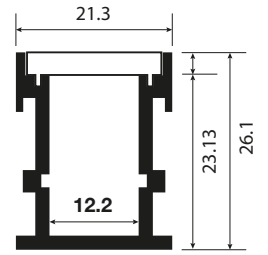

AC5000 (B703)

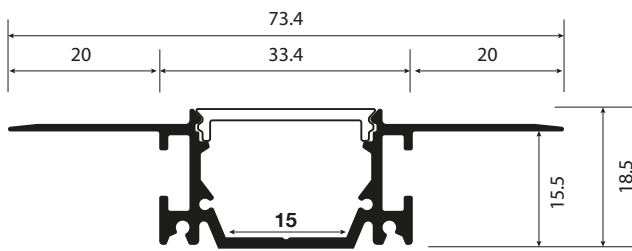

AC9200 (B613)

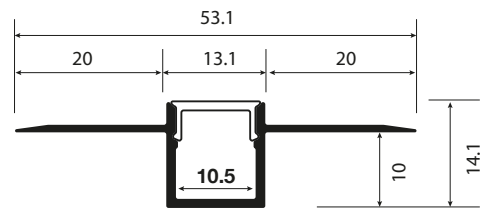

AC9100 (B613)

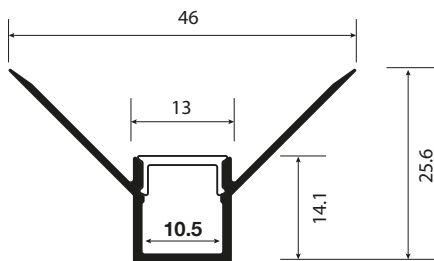

AC9300 (B614)

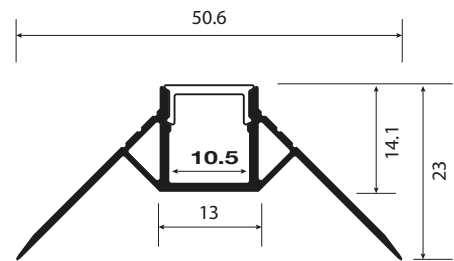

AC9400 (B614)

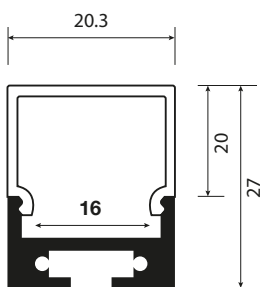

AC6400C (B511)

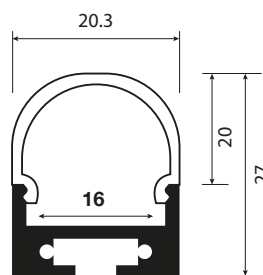

AC6400R (B512)

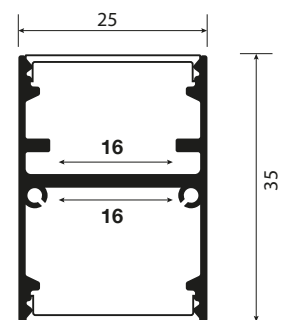

AC3800 (B514)
NEW

ÉCHELLE 1:1

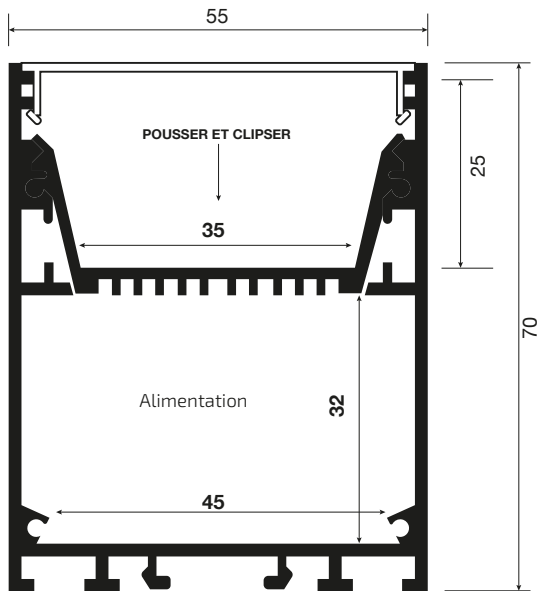

AC3100 (B503)
AC3100B (B504)
AC3100N (B505)

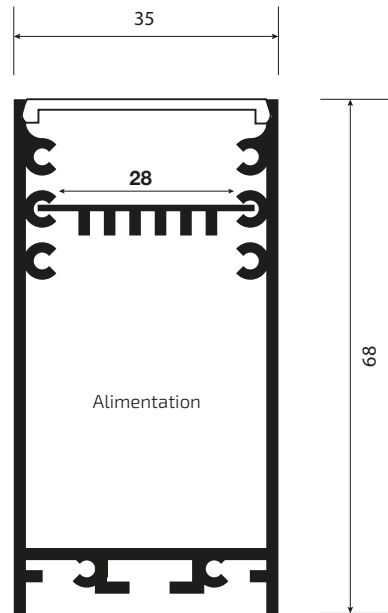

AC6300 (B501)
NEW

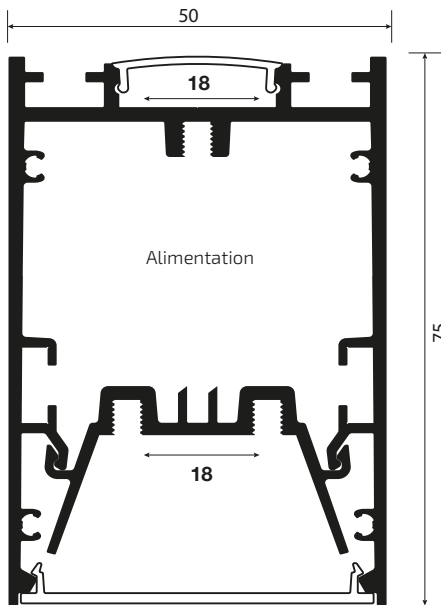

AC3600 (B507)
NEW

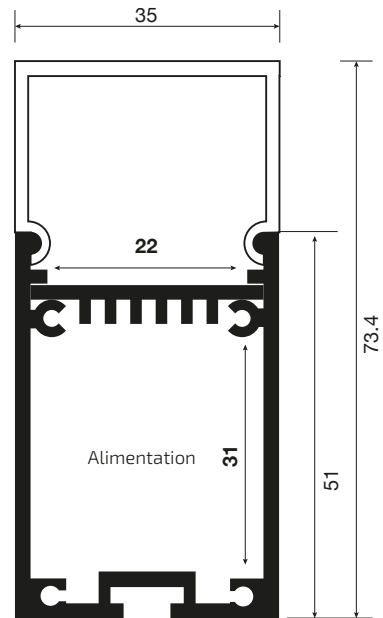

AC3200 (B502)

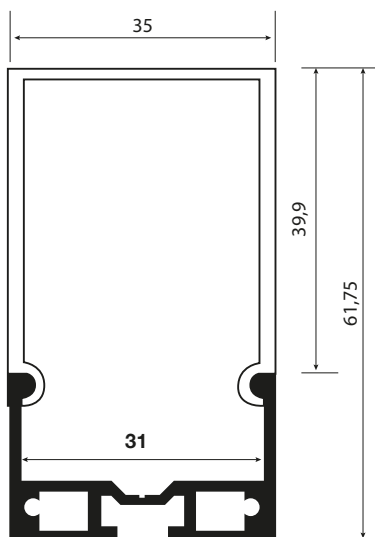

AC3500C (B513)

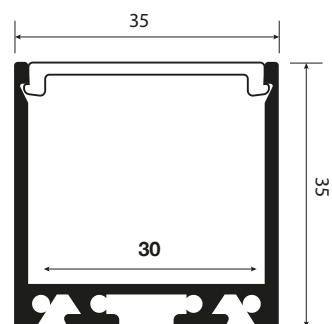

AC6100 (B216)
NEW

ÉCHELLE 1:1

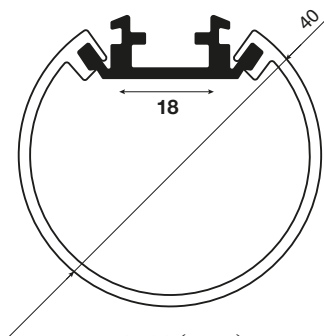

AC3400 (B508)
NEW

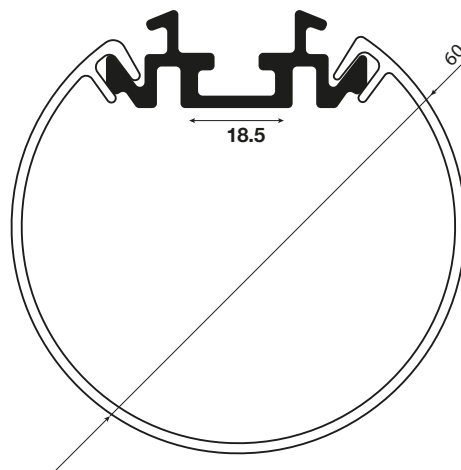

AC3700 (B509)
NEW

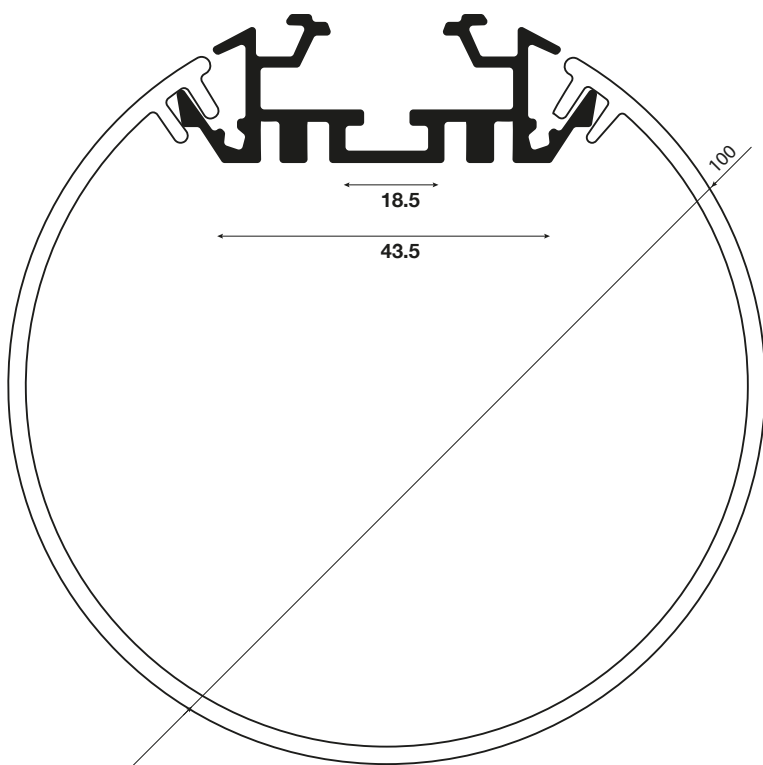

AC3900 (B510)
NEW

ÉCHELLE 1:1

Veillez remplir vos coordonnées :

Nom et prénom

Entreprise

Adresse
de l'entreprise

Date de la demande